

# LGE-7-27

Low Profile LTE & GPS

22/09/2015 v.1

## Low Profile 2G/3G/4G Antenna With GPS

Rugged Low Profile Design

Wideband LTE-Cellular Element

GPS/GNSS/BEIDOU 26dB LNA

Weatherproof Casing



The LG[P]E antenna series is a range of low profile antennas incorporating a combination of wideband cellular elements covering 2G/3G and 4G frequencies along with a GPS/GNSS/BEIDOU element in a robust compact housing.

Designed to be tough yet cost effective, the antennas are completely enclosed in a moulded housing made from weather and impact resistant plastic. The range is supplied with short fly leads and can be kitted with Panorama Antennas' low loss extension cables in various lengths.

### Ground Plane Independent

This antenna does not require a ground plane, and maintains a high level of performance even when mounted on a non-metallic surface.

### Technical Drawing

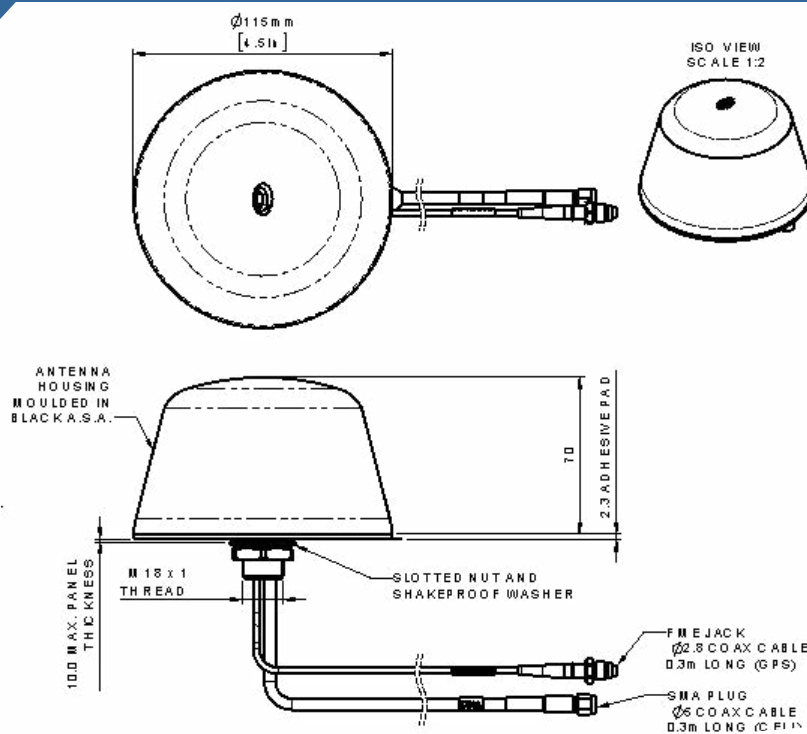

**PANORAMA ANTENNAS**  
Panorama Antennas Ltd  
Frogmore, London, SW18 1HF, United Kingdom

T: +44 (0)20 8877 4444  
F: +44 (0)20 8877 4477  
E: sales@panorama-antennas.com  
www.panorama-antennas.com

Waiver: The data given above is indicative of the performance of the product/s under particular conditions and does not imply a guarantee of performance. These specifications are subject to change without notice.

Copyright © Panorama Antennas Ltd. All rights reserved.

<b>Part No.</b>		LGE-7-27	
<b>Electrical Data</b>			
Frequency Range (MHz)	Element 1	698-960 / 1700-2700	
	Element 2	1560-1612	
Operational Bands	Element 1	LTE / Cellular	
	Element 2	GPS/GNSS/BEIDOU	
Peak Gain: Isotropic	Element 1	698-960MHz	4dBi
		1710-2700MHz	6dBi
Typical VSWR	Element 1	≤ 2.5:1	
Polarisation		Vertical	
Impedance		50Ω	
Max Input Power (W)		50	
<b>GPS Data</b>			
Frequency Range (MHz)		1560-1612	
VSWR		<2.0:1	
Gain: LNA		26dB	
Polarisation		Right Hand Circular	
Operating Voltage		3 -5V DC (fed via coax)	
Current		Typical 15mA	
<b>Mechanical Data</b>			
Dimensions	Height	2.8" (70mm)	
	Diameter	4.5" (115mm)	
Operating Temp		-22° / 176°F (-30° / +80°C )	
Material		A.S.A	
Colour		Black	
<b>Mounting Data</b>			
Mounting type		Panel mount	
Max panel thickness		0.4" (10mm)	
Mounting hole		3/4" (19mm)	
<b>Cable Data</b>			
Cell / LTE Cable	Type	CS29 (double shielded RG58)	
	Diameter	0.2" (5mm)	
	Length	1' (0.3m)	
	Termination	SMA (male)	
GPS Cable	Type	RG174	
	Diameter	0.11" (2.8mm)	
	Length	1' (0.3m)	
	Termination	FME (female)	

We recommend the customer uses Panorama CS29 extension cables for 2G/3G/4G, CS32 extension cables for WLAN and RG174 or CS23 for GPS.

Typical VSWR cellular / LTE element 1\*

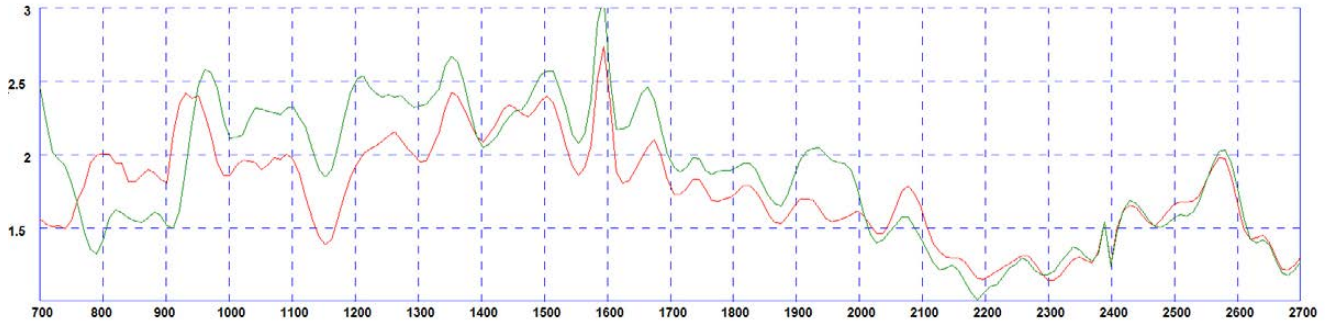

\* Red VSWR measured in on a 400 x400mm (1.3' x 1.3') ground plane without extension cables.  
Green VSWR measured in free space without extension cables.

Typical 3D Pattern - Element 1 700MHz

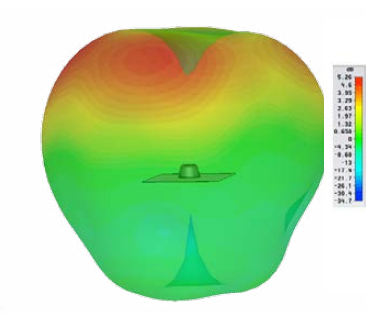

Typical 3D Pattern - Element 1 800MHz

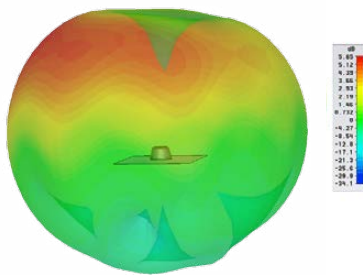

Typical 3D Pattern - Element 1 900MHz

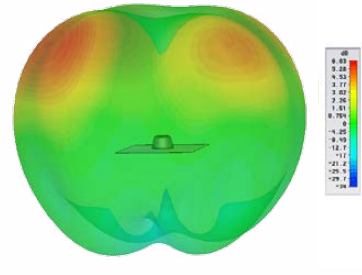

Typical 3D Pattern - Element 1 1800MHz

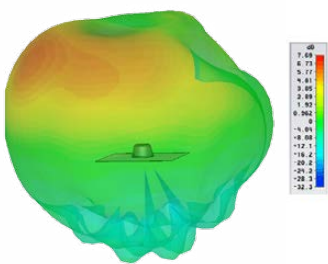

Typical 3D Pattern - Element 1 2000MHz

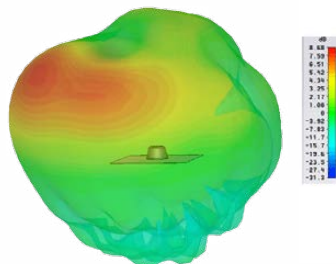

Typical 3D Pattern - Element 1 2600MHz

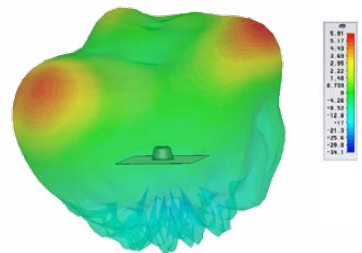

Typical H-Plane (700MHz)

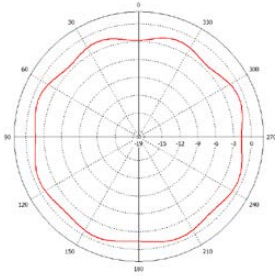

Typical H-Plane (800MHz)

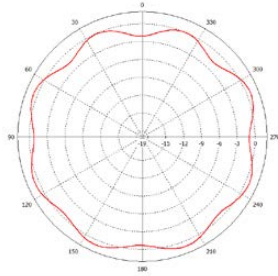

Typical H-Plane (900MHz)

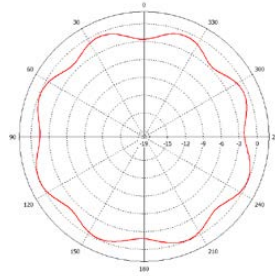

Typical H-Plane (1.7GHz)

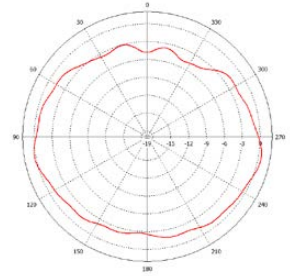

Typical H-Plane (1.9GHz)

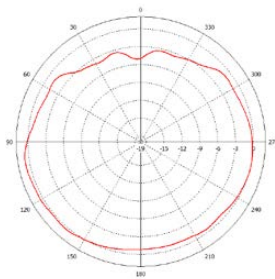

Typical H-Plane (2.7GHz)

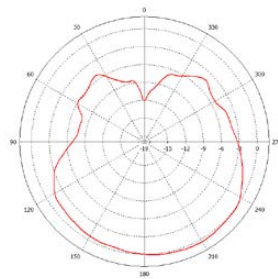

| All pattern and gain measurements taken on a 400 x 400mm (2' x 2') ground plane without additional cable.

**Panorama Antennas Ltd**

Frogmore, London, SW18 1HF, United Kingdom

T: +44 (0)20 8877 4444

F: +44 (0)20 8877 4477

E: [sales@panorama-antennas.com](mailto:sales@panorama-antennas.com)

[www.panorama-antennas.com](http://www.panorama-antennas.com)

Waiver: The data given above is indicative of the performance of the product/s under particular conditions and does not imply a guarantee of performance. These specifications are subject to change without notice.

Copyright © Panorama Antennas Ltd. All rights reserved.

*PANORAMA*  *ANTENNAS*